

# VOGLER<sup>®</sup>

TOOLS, WORK, INTEGRITY



Vogler Tools  
Catalogue - 2024

TECHNOLOGY BY  
GERMANY



[www.voglertools.de](http://www.voglertools.de)

**Our tools embody precision and quality, crafted with advanced German technology. Perfect for professionals who value innovation and reliability.**

**VOGLER**<sup>®</sup>  
TOOLS, WORK, INTEGRITY

We empower you to perform your  
work with integrity



TECHNOLOGY BY  
**GERMANY**  
[www.voglertools.de](http://www.voglertools.de)

**EXCELLENCE THROUGH DEDICATION, QUALITY  
THROUGH CRAFTSMANSHIP**

Tools, Work, Integrity means Vogler isn't just about tools and equipment. It's also about "Doing the right thing, even when no one is watching". Growing to overcome challenges, we are ready to take chances for a better future.

You can rarely find anyone who hasn't worked with tools. They make our lives easier and that's what Vogler's values are based on: To empower everyone with high-quality tools produced with the latest German technology. We create our tools while conforming to world standards with special consideration toward the environment and the user's health and safety.



# SYMBOL GUIDE



**3-Speed**



**Sharp And Cut**



**Anti-Dust Switch**



**Automatic Lubricating System**



**Auto Shut-Off**



**Auto Stop**



**Brushless Motor**



**Bush Pruning**



**Chain Adjustment**



**Chain Tension Adjustment**



**Max Capacity in Concrete**



**Max Diameter of Saw Blade**



**Suitable for Wood Cutting, Gardening Pruning, Small Branch Pruning**



**Suitable for Use With Detergents**



**Digital Pressure Gauge**



**DIY**



**The Electronic Brake**



**Electronic Current Limiter**



**Adjustable Nozzle**



**Electronic Management System**



**Fast Charge**



**General Repair**



**Grand Polish**



**Hexagon Chuck**



**HVLP**



**Vortex Design of Fan**



**Waterproof**



**Clearing Wet Leaves**



**Suitable for Cutting Wood**



**LED**



**Lightweight**



**Low Noise Level**



**Low-Voltage Protection**



**Overcurrent Protection**



**Max Capacity in Masonry**



**Metal Polish**



**Ideal for Woodworking**



**Max Capacity in Wood**



**Max Capacity in Metal**



**Overload Protection**



**Suitable for Plaster**



**Self-Priming**



**Short-Circuit Protection**



**Soft Start**



**Multi-Function Nozzle**



**Max Capacity in Steel**



**Over-Temperature Protection**



**Ideal for Working in Tight Spaces**



**Suitable for Tile**



**Both Forward and Reverse Rotations**



**Both Left and Right Rotations**



**Both Blowing and Vacuuming Functions**



**Variable Speed**



**Switch Reverse Self-Locking**



**Inflating Tyer**

# TABLE OF CONTENTS

---

**V10300**

Brushless Impact Drill 20V

**V10400**

Cordless Impact Drill Driver  
10mm 20V

**V10200**

Brushless Cordless  
Impact Drill 16V

**V10310**

Brushless Cordless  
Screwdriver 20V

**V10210**

Brushless Cordless  
Screwdriver 16V

**V10320**

Brushless Cordless Impact  
Wrench 350N.m 1/2 Inch

**V10321**

Brushless Cordless  
Impact Wrench 20V

**V10322**

Brushless Cordless  
Impact Wrench 20V

**V10340**

Brushless Cordless  
Angle Grinder 125mm

**V10343**

Brushless  
Multi-Functional Tool 20V

**V10345**

Cordless Brushless  
Polisher 20V

**V10356**

Brushless  
Circular Saw 20V

**V10465**

Cordless Planer 20V

**V10330**

Brushless Cordless  
Rotary Hammer 24mm

**V10331**

Brushless Cordless  
Rotary Hammer 30mm

**V10472**

Cordless Blower 20V

**V10471**

Cordless Blower 20V

**V10488**

Cordless Mini Compressor 20V

**V10487**

Cordless Spray Gun 20V

**V10478**

Cordless Chainsaw 20V

**V10377**

Brushless Chainsaw 20V

**V10376**

Brushless Chainsaw 20V

**V10479**

Cordless Pole Saw 20V

**V10380**

Brushless Cordless Pruner  
28mm 20V

**V10483**

Cordless Pressure Washer 20V

**V10383**

Brushless Cordless Pressure  
Washer 20V

**V10490**

Cordless Nailer F30 20V

**V10492**

Cordless Ratchet Wrench 20V

**V18300**

Battery 20V 2000mAh  
Li-ion Battery

**V18305**

Battery 20V 2000mAh  
Li-ion Battery

**V18301**

Battery 20V 4000mAh  
Li-Ion Battery

**V18306**

Battery 20V 4000mAh  
Li-ion Battery

**V19300**

Fast Charger

**V19305**

Charger

**V19302**

Fast Charger

**V18205**

Battery 2000mAh  
Li-ion Battery

**V19205**

Charger

**V19301**

Fast Charger

**V19303**

Fast Charger

# V10300

## Brushless Impact Drill 20V

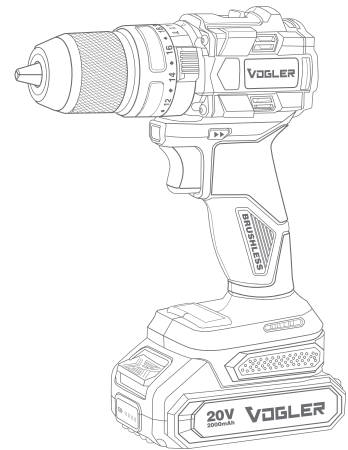

### TECHNICAL SPECIFICATION

Model	V10300
Battery Voltage	20V-2000mAh
Battery Type	Lithium-ion
Chuck Type	Keyless Chuck
Chuck Size	13mm
No-Load Speed	0-450RPM 0-2000RPM
Impact Frequency	0-30000BPM
Max Torque	60N·m
Max Capacity in Wood	35mm
Max Capacity in Metal	12mm
Max Capacity in Concrete	8mm
Weight	1.43Kg (with 1Pc Battery Pack)
Packaging	BMC
Accessories	2Pcs Battery Packs 1Pc Charger

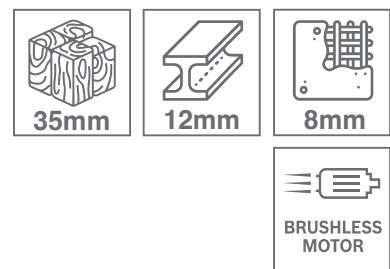

- Super-power hammer drill with 3 functions: Drilling, screwing, and hammer drilling
- 60 N.m maximum torque delivers exceptional power and outstanding performance
- Lightweight ergonomic design: A compact body with considerable power





TECHNOLOGY BY  
**GERMANY**



[www.voglertools.de](http://www.voglertools.de)

**0-450** RPM

**0-2000** RPM

**13** mm Chuck Size

**20V-2000** mAh

**60** N.m

**Lithium-ion**

**1.43** Kg  
with 1Pc Battery Pack



# V10400

## Cordless Impact Drill Driver 10mm 20V

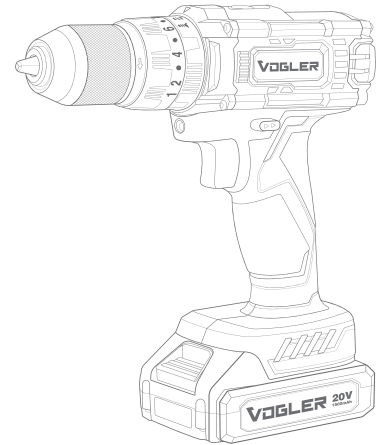

### TECHNICAL SPECIFICATION

Model	V10400
Battery Type	Lithium-ion
Chuck Type	Keyless Chuck
Chuck Size	10mm
Battery Voltage	20V
Battery Capacity	1500mAh
No-Load Speed	0-400RPM 0-1500RPM
Max Torque	35N.m
Max Capacity in Wood	20mm
Max Capacity in Steel	10mm
Max Capacity in Masonry	13mm
Weight	1.33Kg
Charging Time	55min
Packaging	BMC
Accessories	2Pcs Battery Packs 1Pc Charger

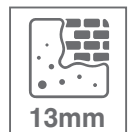
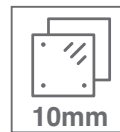
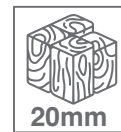

- Powerful, high-performance drill with 3 functions: Drilling, screwing, and hammer drilling
- 18 clutch settings enable efficient and accurate screwing while reducing fastener damage





[www.voglertools.de](http://www.voglertools.de)

**0-400 RPM**  
**0-1500 RPM**

**10 mm**  
Chuck Size

**1500 mAh**

**35 N.m**

**Lithium-ion**

**1.33 Kg**  
with 1Pc Battery Pack

**VOGLER** 20V  
1500mAh

# V10200

## Brushless Cordless Impact Drill 16V

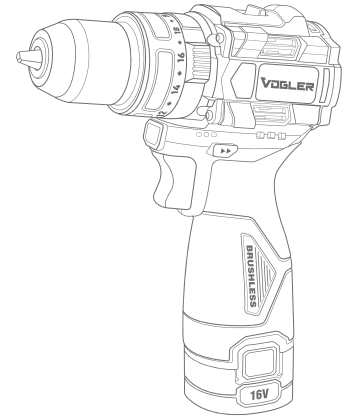

### TECHNICAL SPECIFICATION

Model	V10200
Battery Type	Lithium-ion
Battery Voltage	16V-2000mAh
Chuck Type	Keyless Chuck
Chuck Size	10mm
No-Load Speed	0-450RPM 0-2000RPM
Impact Frequency	0-30000BPM
Max Torque	50N·m
Max Capacity in Wood	25mm
Max Capacity in Metal	10mm
Max Capacity in Concrete	8mm
Weight	1.08Kg (with 1Pc Battery Pack)
Packaging	BMC
Accessories	2Pcs Battery Packs 1Pc Charger

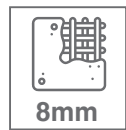
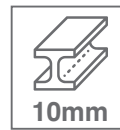
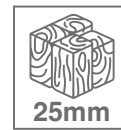

- Super-power hammer drill with 3 functions: Drilling, screwing, and hammer drilling
- 20+3 clutch settings enable efficient and accurate screwing while reducing fastener damage





TECHNOLOGY BY  
**GERMANY**



[www.voglertools.de](http://www.voglertools.de)

0-450 RPM  
0-2000 RPM

**10** mm Chuck Size

**2000** mAh

**50** N.m

**Lithium-ion**

**1.08** Kg  
with 1Pc Battery Pack

# V10310

## Brushless Cordless Screwdriver 20V

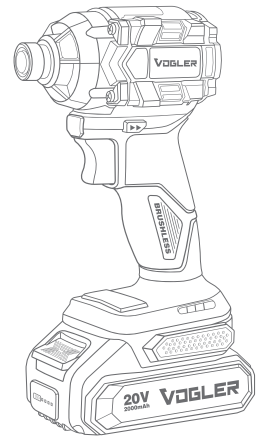

### TECHNICAL SPECIFICATION

Model	V10310
Battery Type	Lithium-ion
Chuck Type	Hex Socket
Chuck Size	6.35mm-1/4"
Battery Voltage	20V
Battery Capacity	2000mAh
No-Load Speed	0-3300RPM
Max Torque	230N·m
Weight	1.38Kg (with 1Pc Battery Pack)
Packaging	BMC
Accessories	2Pcs Battery Packs 1Pc Charger 3Pcs Hex Shank Twist Drill (φ 3.2mm/4.2mm/5.2mm) 2Pcs Heel Block

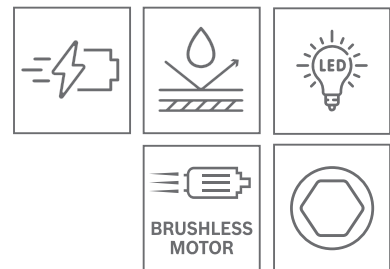

- 20V powerful brushless motor delivers optimal performance for screwing
- Intelligent hexagon chuck ensures easy and quick bit changing
- High-resistant waterproof motor enables reliable operation in wet conditions



TECHNOLOGY BY  
**GERMANY**



[www.voglertools.de](http://www.voglertools.de)

**0-3300** RPM

**6.35mm - 1/4"**  
Chuck Size

**2000** mAh

**230** N.m

**Lithium-ion**

**1.38** Kg  
with 1Pc Battery Pack



# V10210

## Brushless Cordless Screwdriver 16V

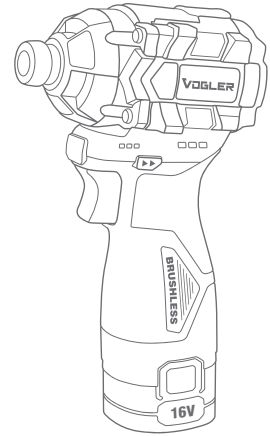

### TECHNICAL SPECIFICATION

Model	V10210
Battery Type	Lithium-ion
Chuck Type	Hex Socket
Chuck Size	6.35mm/1/4"
Impact Frequency	0-4000BPM
Battery Voltage	16V
Battery Capacity	2000mAh
No-Load Speed	0-3200RPM
Max Torque	150N·m
Weight	1.06Kg (with 1Pc Battery Pack)
Packaging	BMC
Accessories	2Pcs Battery Packs 1Pc Charger 3Pcs Hex Shank Twist Drill (φ3.2mm/4.2mm/5.2mm) 2Pcs Heel Block

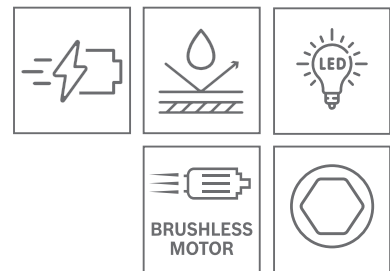

- 16V powerful brushless motor delivers superior performance for screwing
- High-torque setting system with an impressive 150 N.m torque ensures efficient and precise screwing
- Ergonomic, compact, and lightweight design, weighing only 0.82 Kg, makes it ideal for working in confined spaces





[www.voglertools.de](http://www.voglertools.de)

**0-3200** RPM

**6.35mm - 1/4"**  
Chuck Size

**2000** mAh

**150** N.m

**Lithium-ion**

**1.06** Kg  
with 1Pc Battery Pack



# V10320

## Brushless Cordless Impact Wrench 350N.m 1/2 INCH

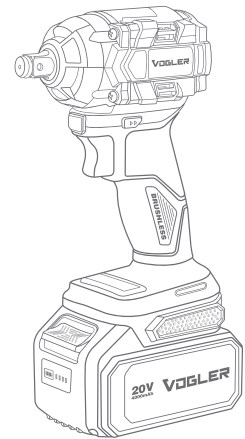

### TECHNICAL SPECIFICATION

Model	V10320
Battery Voltage	20V/4000mAh
Battery Type	Lithium-ion
Chuck Size	12.7mm/1/2In Square
No-Load Speed	0-2400RPM
Impact Frequency	0-3500BPM
Standard Bolt	M8-M18
High-Tensile Bolt	M6-M14
Max Torque	350N.m
Weight	1.66Kg (with 1Pc Battery Pack)
Packaging	BMC
Accessories	2Pcs Battery Packs 1Pc Charger 1Pc Sleeve $\varnothing$ 22mm 1Pc Rubber Ring 1Pc Sleeve Cylindrical Pin

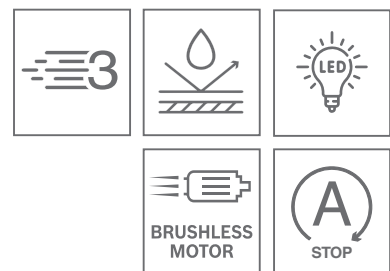

- High-efficiency 1/2" impact wrench delivers 350 N.m torque for outstanding performance.
- 3-speed control for High, Medium, and Low RPM & IPM, providing precision fastening across a wide range of applications.





[www.voglertools.de](http://www.voglertools.de)

**0-2400 RPM**

**12.7 mm - 1/2" Square**  
Chuck Size

**20 V - 4000 mAh**

**350 N.m**

**Lithium-ion**

**1.66 Kg**  
with 1Pc Battery Pack



# V10321

## Brushless Cordless Impact Wrench

### 20V

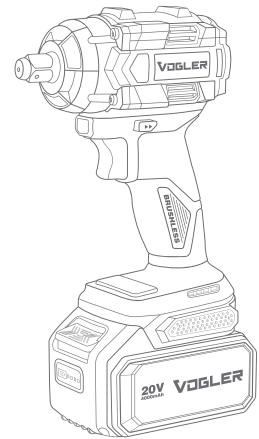

#### TECHNICAL SPECIFICATION

Model	V10321
Battery Voltage	20V/4000mAh
Battery Type	Lithium-ion
Chuck Size	12.7mm-1/2"
No-Load Speed	0-2500RPM
Impact Frequency	0-3300BPM
Standard Bolt	M10-M24
High Tensile Bolt	M8-M20
Head Style	Square
Max Torque	500N·m
Weight	1.8Kg (with 1Pc Battery Pack)
Packaging	BMC
Accessories	2Pcs Battery Packs 1Pc Charger 1Pc Sleeve $\phi$ 22mm 1Pc Rubber Ring 1Pc Sleeve Cylindrical Pin

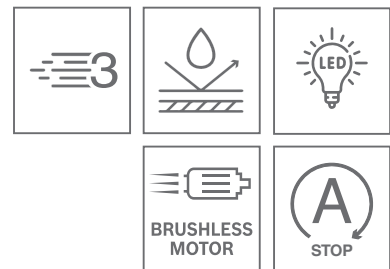

- High-efficiency, fast-hitting 1/2" impact wrench delivers 500 N.m torque for exceptional performance
- High-resistance, anti-shock body with an ergonomic rubber grip for enhanced durability and comfort





TECHNOLOGY BY  
**GERMANY**



[www.voglertools.de](http://www.voglertools.de)

**0-2500** RPM

**12.7 mm - 1/2"**  
Chuck Size

**20 v - 4000** mAh

**500** N.m

**Lithium-ion**

**1.8** Kg  
with 1Pc Battery Pack

# V10322

## Brushless Cordless Impact Wrench

### 20V

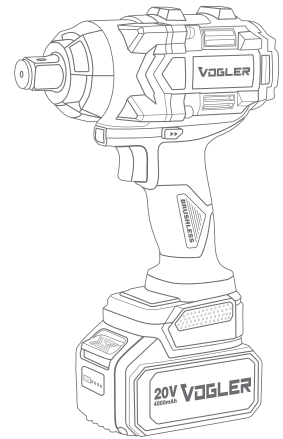

#### TECHNICAL SPECIFICATION

Model	V10322
Battery Voltage	20V/4000mAh
Battery Type	Lithium-ion
Chuck Size	12.7mm: 1/2" 19mm: 3/4"
No-Load Speed	0-1800RPM
Impact Frequency	0-2200BPM
Head Style	Square
High-Tensile Bolt	M12-M24
Standard Bolt	M14-M30
Max Torque	1000N·m
Weight	2.96Kg (with 1Pc Battery Pack)
Packaging	BMC
Accessories	2Pcs Battery Packs 1Pc Charger 1Pc Cylindrical Pin 1Pc O-Ring 1Pc Sleeve Rubber Ring 1Pc 1/2" Square Shaft

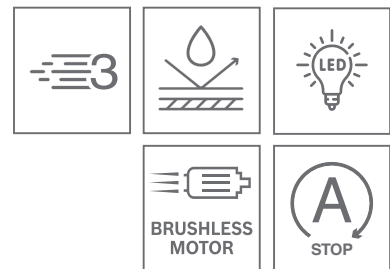

- Lightweight, ergonomic, and compact design offers considerable power
- High-resistance, anti-shock body with an ergonomic rubber grip ensures durability and comfort
- High-efficiency, fast-hitting 1/2" (3/4") impact wrench delivers 1000 N.m torque for outstanding performance, featuring a 12.7 mm (1/2") - 19 mm (3/4") changeable drive for versatility





[www.voglertools.de](http://www.voglertools.de)

**0-1800** RPM

**20V-4000** mAh

**Lithium-ion**

**1000** N.m

**12.7** mm: 1/2"

**19** mm: 3/4"

Chuck Size

**2.96** Kg

with 1Pc Battery Pack

**20V**  
4000mAh **VOGLER**

# V10340

## Brushless Cordless Angle Grinder 125mm

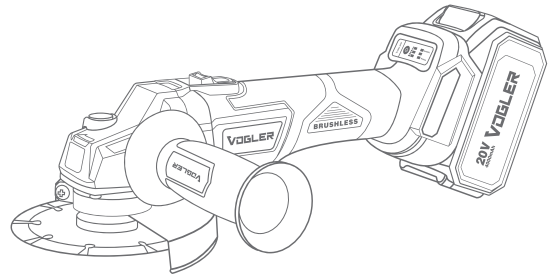

### TECHNICAL SPECIFICATION

Model	V10340
Battery Capacity	20V-4000mAh
Battery Type	Lithium-ion
Spindle Size	M14
No-Load Speed	2600/8500RPM
Disc Diameter	125mm
Weight	1.96Kg (with 1Pc Battery Pack)
Packaging	BMC
Accessories	2Pcs Battery Packs 1Pc Charger 1Pc Guard 1Pc Wrench 1Pc Auxiliary Handle

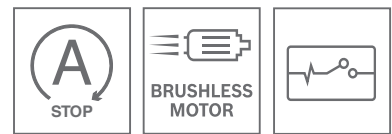

- The ON/OFF trigger switch features a no-volt release function. In the event of a power outage or unexpected shutdown, the trigger switch must be cycled (turned off and then on) to restart the tool



**VOGLER**<sup>®</sup>  
TOOLS, WORK, INTEGRITY



[www.voglertools.de](http://www.voglertools.de)

**2600-8500 RPM**

**125 mm**

**20 V-4000 mAh**

**M14 Spindle Size**

**Lithium-ion**

**1.96 Kg**  
with 1Pc Battery Pack



# V10343

## Brushless Multi-Functional Tool 20V

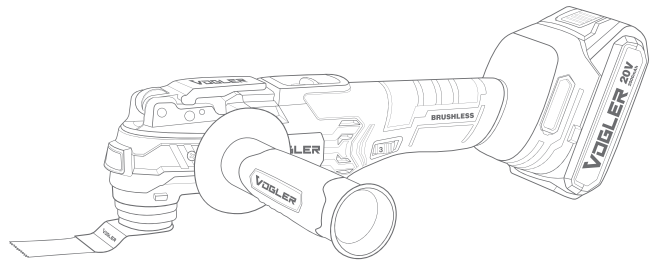

### TECHNICAL SPECIFICATION

Model	V10343
Dimension	290×75×92mm
Voltage	20V
Battery Type	Lithium-ion
Battery Capacity	2000mAh
Oscillation Angle	4.2°
Max Speed	20000RPM
Min Speed	8000RPM
Charging Time	60min
Body Material	Metal, Plastic, Aluminum
Net Weight	2.35Kg
Total Weight	2.85Kg

Accessories	2Pcs Battery Packs 1Pc Charger 1Pc Saw Blade 1Pc Stainless Scraper 1Pc Sanding Disc 3Pcs Sanding Paper
-------------	---

- Equipped with an LED light to illuminate dark work surfaces
- Variable speed control ranging from 8,000 to 20,000 RPM, with a 4.2° oscillation angle for precise cutting and grinding tasks
- Soft start technology ensures precise positioning on the workpiece, while the smooth-running motor delivers perfect results





[www.voglertools.de](http://www.voglertools.de)

**8000-20000** RPM      **60min**  
Charging Time

**Lithium-ion**      **2000** mAh

**Metal**      **2.85** Kg  
**Plastic**  
**Aluminum**

# V10345

## CORDLESS BRUSHLESS POLISHER 20V

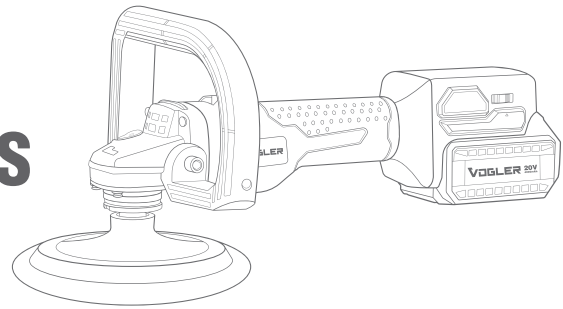

### TECHNICAL SPECIFICATION

Model	V10345
Battery Voltage	20V
Battery Capacity	4000mAh
Battery Type	Lithium-ion
No-Load Speed	1300-3500RPM
Spindle Size	M14
Pad Diameter	150mm
Charging Time	60min
Weight	2.43Kg
Packaging	BMC
Accessories	1Pc Sheep Ball 1Pc Polishing Disc 1Pc Hex Wrench 1Pc Handle 2 Sets Screws

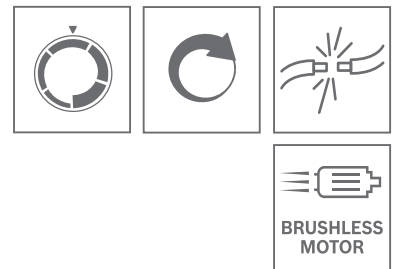

- High-efficiency, robust brushless motor ensures maximum productivity and top performance across various functions
- Variable speed control dial ranging from 1,300 to 3,500 RPM allows users to match the speed to the application





[www.voglertools.de](http://www.voglertools.de)

**1300-3500** RPM      **M14** Spindle Size

**150** mm Pad Diameter      **4000** mAh

**Lithium-ion**      **2.43** Kg

# V10356

## BRUSHLESS CIRCULAR SAW 20V

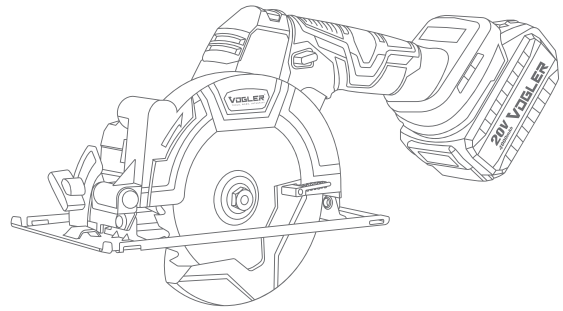

### TECHNICAL SPECIFICATION

Model	V10356
Battery Voltage	20V
Battery Capacity	4000mAh
Battery Type	Lithium-ion
No-Load Speed	6000RPM
Max Cutting Depth at 0°	42mm
Max Cutting Depth at 45°	30mm
Disc Bore Size	Φ20mm
Saw Blade Max Diameter	125mm
Switch Type	Anti-Self-Locking Switch
Cutting Angles	0°/45°
Charging Time	60min
Weight	2.67Kg

Accessories	1Pc Inner Hexagon Spanner 1Pc Guide 1Pc 4.0Ah Battery Pack 1Pc 4.0A Charger
-------------	--

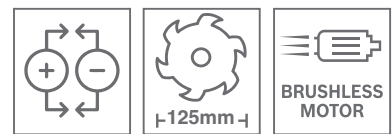

- Powerful, high-performance brushless motor delivers 6,000 RPM for greater speed and faster cuts
- Steel base plate enables precise bevel cuts at common angles from 0° to 45°
- Well-balanced design ensures superior handling and performance





[www.voglertools.de](http://www.voglertools.de)

**6000** RPM

**125** mm  
Saw Blade Max Diameter

**20**v

**4000** mAh

**Lithium-ion**

**2.67** Kg

# V10465

## Cordless Planer 20V

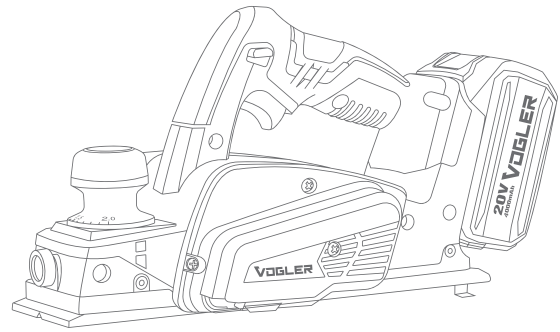

### TECHNICAL SPECIFICATION

Model	V10465
Battery Capacity	4000mAh
Battery Voltage	20V
Battery Type	Lithium-ion
No-Load Speed	15000RPM
Cutting Depth	82x2mm
Motor Type	Brushed Motor
Blade Material	65Mn
Charging Time	60min
Switch Type	Trigger Switch
Weight	3.27Kg (with 1Pc Battery Pack)
Packaging	BMC
Accessories	1Pc Guide Plate 1Pc Hex Wrench 8# 1Pc Internal Hex Wrench 1Pc Charger 2Pcs Battery Packs



- Capable of generating a No-Load Speed of 15,000 RPM for high efficiency
- Equipped with switch reverse self-locking for enhanced application safety
- Ideal for woodworking tasks, including fixing doors, fitting wood, and correcting splinters, chips, and misshapen edges





[www.voglertools.de](http://www.voglertools.de)

**15000** RPM

**82x2** mm  
Cutting Depth

**20** v

**4000** mAh

**Lithium-ion**

**3.27** Kg  
with 1Pc Battery Pack



# V10330

## Brushless Cordless Rotary Hammer 24mm

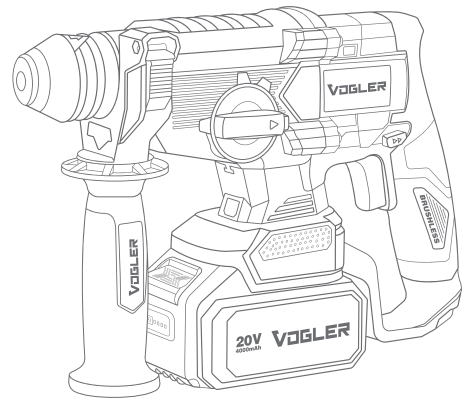

### TECHNICAL SPECIFICATION

Model	V10330
Chuck Type	SDS-Plus
Chuck Size	10mm
Battery Type	Lithium-ion
Battery Voltage	20V
Battery Capacity	4000mAh
Impact Energy	2.5J
Max Capacity in Concrete	22mm
No-Load Speed	0-1400RPM
Impact Frequency	0-4800BPM
Weight	2.71Kg (with 1Pc Battery Pack)
Packaging	BMC
Accessories	2Pcs Battery Packs 1Pc Charger 1Pc Auxiliary Handle 1Pc Guide Ruler

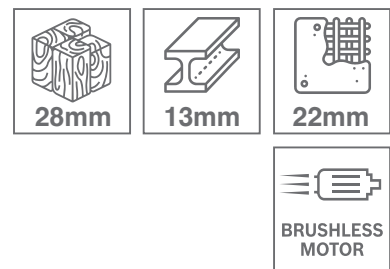

- Ergonomic soft-grip handle ensures better handling during operation
- SDS Plus tool-free bit system with an automatic bit-locking mechanism for convenience
- High-efficiency, powerful rotary hammer drill with 4 functions: Drilling, hammer drilling, chiseling, and releasing





TECHNOLOGY BY  
**GERMANY**



[www.voglertools.de](http://www.voglertools.de)

**0-1400** RPM

**SDS-Plus**

**2.5** J

**20** V

**0-4800** BPM

**2.71** Kg  
with 1Pc Battery Pack

# V10331

## Brushless Cordless Rotary Hammer 30mm

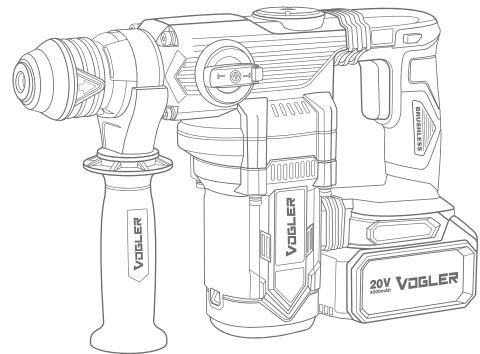

### TECHNICAL SPECIFICATION

Model	V10331
Chuck Type	SDS-Plus
Battery Type	Lithium-ion
Battery Voltage	20V
Battery Capacity	4000mAh
Impact Energy	3.5J
Impact Frequency	0-5400BPM
Chuck Size	10mm
Max Capacity in Concrete	24mm
No-Load Speed	0-1000RPM
Weight	4.26Kg (with 1Pc Battery Pack)
Packaging	BMC
Accessories	2Pcs Battery Packs 1Pc Charger 1Pc Auxiliary handle 1Pc Dust Cover

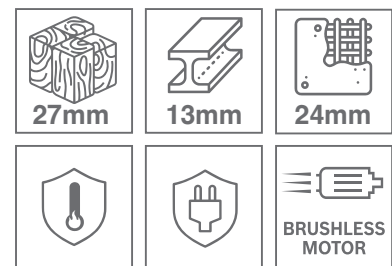

- Ergonomic soft-grip handle ensures better handling during operation
- SDS Plus tool-free bit system with an automatic bit-locking mechanism for convenience
- High-efficiency, powerful rotary hammer drill with 2 functions: Hammer drilling and chiseling





TECHNOLOGY BY  
**GERMANY** 

[www.voglertools.de](http://www.voglertools.de)

**0-1000** RPM

**SDS-Plus**

**3.5** J

**20** V

**Lithium-ion**

**0-5400** BPM

# V10472

## Cordless Blower 20V

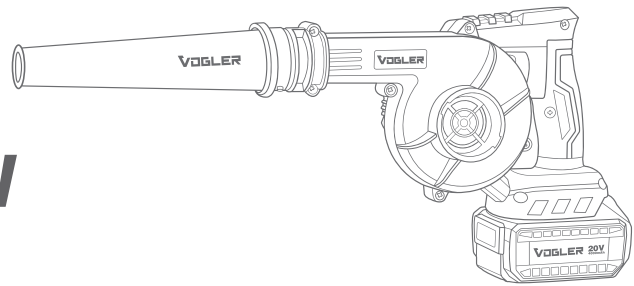

### TECHNICAL SPECIFICATION

Model	V10472
Voltage	20V
Battery Type	Lithium-ion
Battery Capacity	4000mAh
No-Load Speed	0-18000RPM
Maximum Air Flow	0-2.8m <sup>3</sup> /min
Charging Time	60min
Weight	1.87Kg
Accessories	Blow Rubber Tube Dust Bag 1Pc 4Ah Battery 1Pc 4A Charger



- Efficient 20V motor delivers powerful air force for both blowing and vacuuming functions
- Ergonomic design ensures convenient handling during operation





[www.voglertools.de](http://www.voglertools.de)

**0-18000** RPM

**0-2.8 m<sup>3</sup>/min**  
Maximum Air Flow

**20v**

**4000** mAh

**Lithium-ion**

**1.87** Kg

# V10471

## Cordless Blower 20V

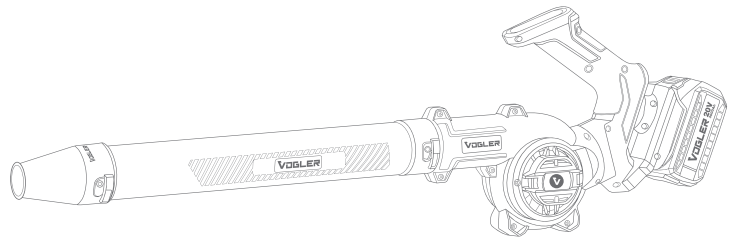

### TECHNICAL SPECIFICATION

Model	V10471
Motor Type	Brushed Motor
Battery Type	Lithium-ion
Battery: Voltage / Capacity	20V/4000mAh
No-Load Speed	20000RPM
Maximum Air Flow	4760L/min 4.76m <sup>3</sup> / min
Max Air Speed	60m/s
Charging Time	60min
Body Material	ABS
Weight	0.81Kg
Accessories	1Pc Extension Tube 4Pcs Blow Nozzles 1Pc Charger 1Pc Battery Pack



- Space-saving design with a detachable blow tube for easy storage
- Built-in low-voltage protection and overcurrent safety features ensure device longevity
- Speed adjustment function allows precise control for various tasks





[www.voglertools.de](http://www.voglertools.de)

**20000** RPM

**60** m/s

**20** v

**4000** mAh

**Lithium-ion**

**0.81** Kg



# V10488

## Cordless Mini Compressor 20V

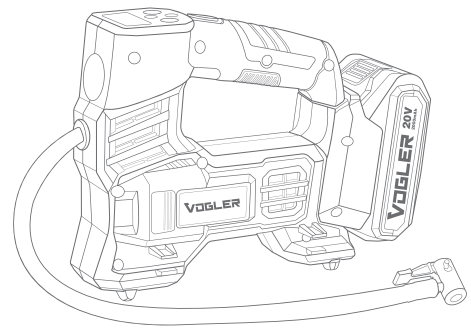

### TECHNICAL SPECIFICATION

Model	V10488
Battery Capacity	2000mAh
Battery Voltage	20V
Battery Type	Lithium-ion
Max Pressure	1035KPA 150PSI 10.35 Bar
Max Air Flow	25L/min
Inflator Hose Length	40cm
LED Flux	120Lumen
Charging Time	60min
Weight	1.3Kg
Accessories	Ball Adaptor Tire Valve Adaptor 1Pc 2.0Ah Battery 1Pc 2.0A Charger 1Pc Inflatable Adaptor

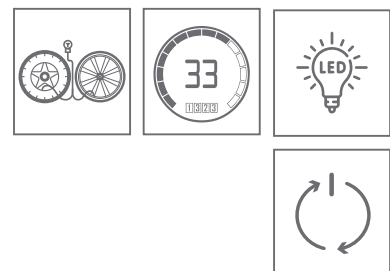

- High-efficiency pump and motor deliver true 150 PSI capability
- Auto shut-off feature activates when the desired air pressure is reached
- Equipped with a high-efficiency LED light, doubling as a flashlight for added versatility





[www.voglertools.de](http://www.voglertools.de)

**25 L/min**  
Max Air Flow

**10.35 BAR**  
150 PSI / 1035 KPA

**20 v**

**2000 mAh**

**Lithium-ion**

**1.3 kg**

# V10487

## Cordless Spray Gun 20V

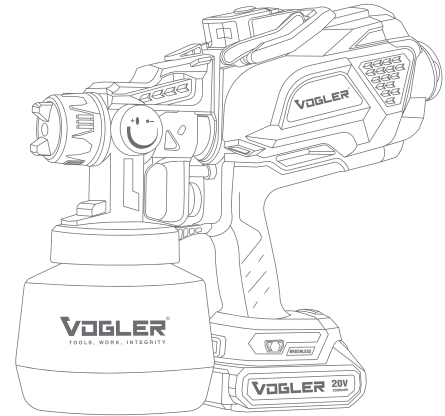

### TECHNICAL SPECIFICATION

Model	V10487
Battery Voltage	20V
Battery Capacity	2000mAh
Paint Reservoir	1200ml
Max. Viscosity	80Din/sec
Max. Flow	980ml/min
Speed	32000RPM
Battery Charging Time	60min
LED Voltage	20V
LED Power	4W
Flux	230Lm
CCT	6500K
Weight	1.5Kg

Accessories

Clean Needle  
Shoulder Strap  
Viscosity Cup  
2 Batteries  
Charger  
Nozzles(1.0mm/1.8mm/2.5mm)  
Spanner

- Easy-to-use handheld cordless paint sprayer delivers a smooth finish without brush marks
- Three brass nozzle sizes (1.0 mm, 1.8 mm, and 2.5 mm) provide versatile spraying options
- Adjustable spray pattern width for precise and customized application

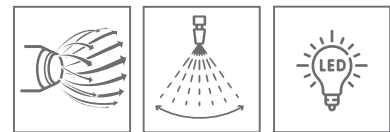



TECHNOLOGY BY  
**GERMANY** 

[www.voglertools.de](http://www.voglertools.de)

**32000** RPM

**20** V  
Battery Voltage

**1.5** Kg

**2000** mAh

**980** ml/min  
Max. Flow

**1200** ml  
Paint Reservoir

# V10478

## Cordless Chainsaw 20V

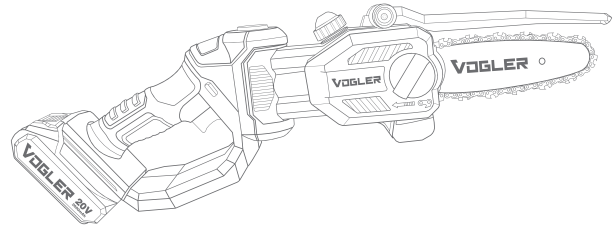

### TECHNICAL SPECIFICATION

Model	V10478
Voltage	20V
Battery Type	Lithium-ion
Battery Capacity	2000mAh
Maximum Cutting Diameter	6"/150mm
Chain Size	1/4"
Chain Bar Length	195mm
No-Load Speed	3800RPM
Chain Speed	4.8m/s
Oil Tank Capacity	50ml
Cuts Per Battery Charge (Cutting Diameter 100mm)	50~60 Pcs
Charging Time	60min
Weight	1.67Kg (with One 2.0Ah Battery)

Accessories	Bar Cover Oil Bottle 50ml 1Pc 3mm File 2Pcs 2.0Ah Batteries 1Pc 2.0A Charger
-------------	--

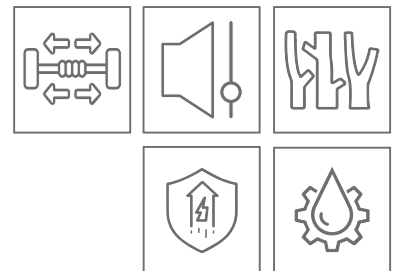

- Professional cordless chainsaw delivers enhanced cutting performance with a powerful motor and a chain speed of 4.8 meters per second





[www.voglertools.de](http://www.voglertools.de)

**3800** RPM

**6"/150** mm  
Maximum Cutting Diameter

**4.8** m/s

**2000** mAh

**Lithium-ion**

**1.67** Kg

# V10377

## Brushless Chainsaw 20V

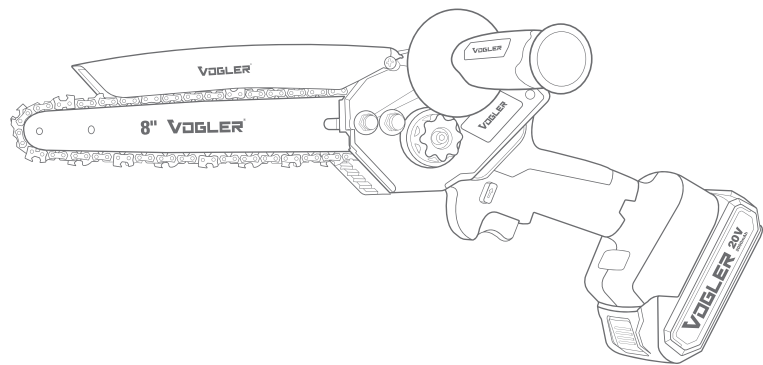

### TECHNICAL SPECIFICATION

Model	V10377
Battery Voltage	20V
Battery Type	Lithium-ion
Battery Capacity	2000mAh
Maximum Cutting Diameter	140mm
Chain Size	290mm
Chain Bar Length	239mm
No-Load Speed	3800RPM
Chain Speed	5m/s
Oil Tank Capacity	25ml
Cuts Per Battery Charge (Cutting Diameter 110mm)	30 Pcs
Charging Time	60min
Net Weight	1.47Kg
Total Weight	2.25Kg
Packaging	BMC

Accessories	2Pcs Batteries 1Pc Charger 1Pc Handle 1Pc Wrench 1Pc Bar Cover
-------------	--

- Professional cordless chainsaw delivers enhanced cutting performance with a powerful brushless motor and a chain speed of 5 meters per second
- Equipped with a safety brake handle and a low-kickback saw chain for user protection

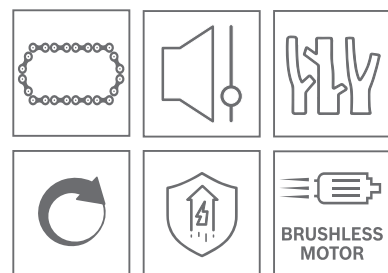



[www.voglertools.de](http://www.voglertools.de)

**3800 RPM**

**140 mm**  
Maximum Cutting Diameter

**5 m/s**

**2000 mAh**

**Lithium-ion**

**1.47 Kg**



# V10376

## Brushless Chainsaw 20V

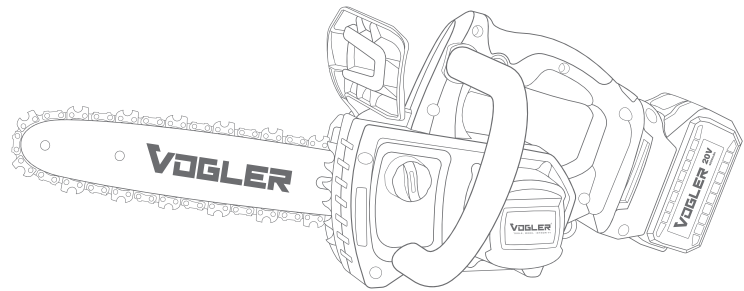

### TECHNICAL SPECIFICATION

Model	V10376
Battery Voltage	20V
Battery Type	Lithium-ion
Battery Capacity	4000mAh
Maximum Cutting Diameter	170mm
Chain Size	10"
Chain Bar Length	254mm
No-Load Speed	3850RPM
Chain Speed	7m/s
Oil Tank Capacity	100ml
Cuts Per Battery Charge (Cutting Diameter 110mm)	71Pcs
Charging Time	60min
Gross Weight	4.58Kg

Accessories	1Pc 10" Guide Bar 1Pc 10" Saw chain 1Pc Chain Cover 1Pc Charger 2Pcs Battery Packs
-------------	--

- Equipped with overcurrent protection for enhanced safety and durability
- Fitted with a safety brake handle to ensure user protection
- Low noise level and zero emissions provide superior operator comfort

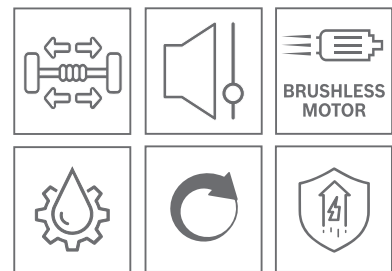



[www.voglertools.de](http://www.voglertools.de)

**3850** RPM

**170** mm  
Maximum Cutting Diameter

**7** m/s

**4000** mAh

**Lithium-ion**

**4.58** kg

# V10479

## Cordless Pole Saw 20V

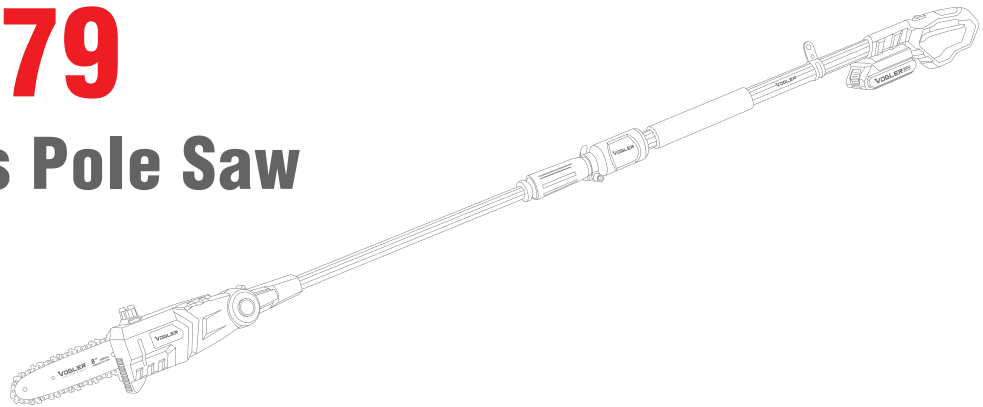

### TECHNICAL SPECIFICATION

Model	V10479
Battery Voltage	20V
Battery Type	Lithium-ion
Battery Capacity	2000mAh
Maximum Cutting Diameter	200mm
Chain Size	8"
Chain Bar Length	200mm
Pole Length	99cm-148cm
No-Load Speed	2700RPM
Chain Speed	5.5m/s
Head Angle	3 Grad (0° 15° 30°)
Oil Tank Capacity	95ml
Cuts Per Battery Charge (Cutting Diameter 35mm)	120Pcs
Charging Time	60min
Total Length	265cm
Weight	3.48Kg

#### Accessories

1Pc Chain  
1Pc Chain Bar  
1Pc Bar Cover  
1Pc Strap  
1Pc Oil Bottle  
2Pcs Battery Packs  
1Pc Charger

- Automatic lubricating system for smooth operation
- Overcurrent protection ensures safety
- Low noise and zero emissions enhance comfort

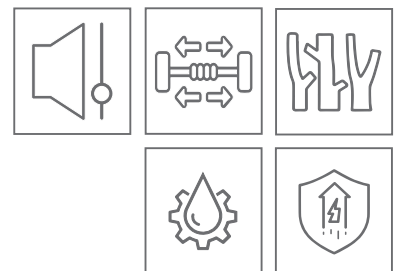

**VOGLER**<sup>®</sup>  
TOOLS, WORK, INTEGRITY



TECHNOLOGY BY  
**GERMANY** 

[www.voglertools.de](http://www.voglertools.de)

**200 mm** **2700 RPM**  
Maximum Cutting Diameter

**5.5 m/s** **2000 mAh**

**Lithium-ion** **3.48 Kg**

# V10380

## Brushless Cordless Pruner 28mm 20V

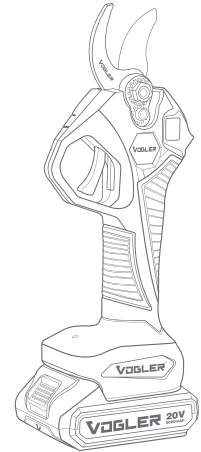

### TECHNICAL SPECIFICATION

Model	V10380
Battery Capacity	2000mAh
Max Cutting Diameter	28mm
Power	600W
Body Material	Nylon
Blade and Jaw Material	SK5
Handle Material	Nylon
Voltage	20V
Battery Type	Lithium-ion
Weight	1.15Kg
Packaging	BMC
Accessories	2Pcs Batteries 1Pc Charger 1Pc Oil Bottle 2Pcs Wrench 1Pc Whetstone

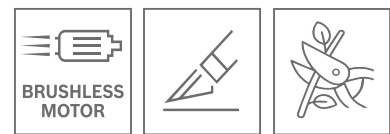

- Electric trimmers are versatile for gardens, parks, farms, orchards, greenhouses, and more
- Equipped with 2 or 3 rechargeable 2Ah lithium batteries for long use; each battery lasts 2-3 hours and charges in 1 hour





[www.voglertools.de](http://www.voglertools.de)

<b>SK5</b> Material of Blade and Jaw	<b>28 mm</b> Max Cutting Diameter
<b>20 v</b>	<b>2000 mAh</b>
<b>Lithium-ion</b>	<b>1.15 Kg</b>

# V10483

## Cordless Pressure Washer 20V

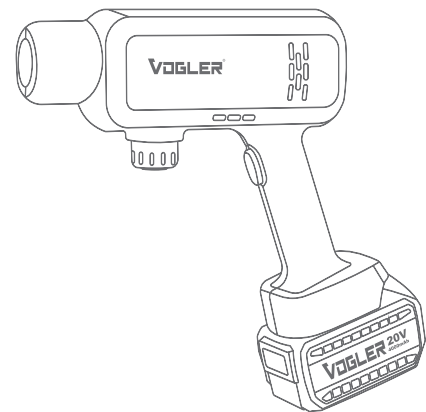

### TECHNICAL SPECIFICATION

Model	V10483
Battery Voltage	20V
Battery Capacity	4000mAh
Max Flow	3.5L/Min
Working Pressure	22 Bar
Water-Sucking Height	1.5m
Spray Response Time	10-30 Seconds
Motor Type	Brushed
Battery Charging Time	60min
Product Dimensions ( Length×Width×Height)	680×265×85mm
Weight	1.52Kg (with 1Pc Battery Pack)
Packaging	Carbon Fiber Bag

#### Accessories

1Pc Battery Pack  
1Pc Charger  
1Pc Foam Tank  
1Pc Filter  
1Pc 6-in-1 Multi-Functional Sprinkler  
1Pc Water Inlet Pipe 5m  
1Pc Lengthened Gun Lever  
1Pc Carbon Fiber Storage Bag

- Self-priming function
- 22-bar working pressure
- Ergonomic trigger design

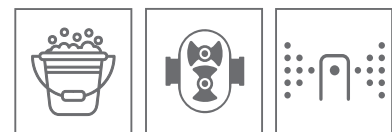



[www.voglertools.de](http://www.voglertools.de)

**6-In-1**  
Multifunctional Sprinkler

**22 Bar**  
Working Pressure

**20 v**

**4000 mAh**

**3.5 Liter/Minute**

**1.52 Kg**  
with 1Pc Battery Pack





# V10383

## Brushless Cordless Pressure Washer 20V

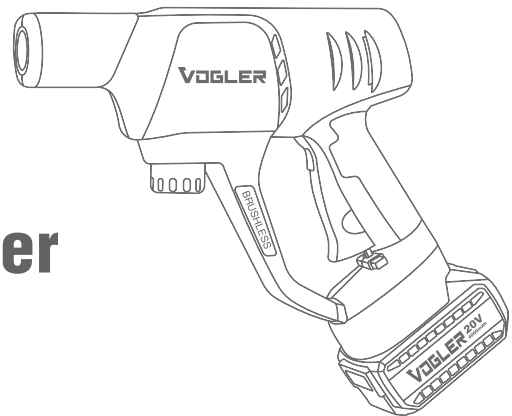

### TECHNICAL SPECIFICATION

Model	V10383
Battery Voltage	20V
Battery Capacity	4000mAh
Max Flow	4L/Min
Working Pressure	IIII Gear: 42-45Bar (652.5PSI) III Gear: 30Bar (435PSI) II Gear: 20Bar (290PSI) I Gear: 13Bar (188.5PSI)
Water-Sucking Height	1.5m
Spray Response Time	10-30Seconds
Battery Charging Time	60min
Product Dimensions ( Length×Width×Height)	1000×85×29mm
Weight	2.12Kg (with 1Pc Battery Pack)
Packaging	Color Box + Carbon Fiber Bag

#### Accessories

1Pc Charger  
 1Pc Battery Pack  
 1Pc Foam Tank  
 1Pc Filter  
 1Pc 6-in-1 Multi-Functional  
 Sprinkler  
 1Pc Water Inlet Pipe 5m  
 2Pcs Lengthened Gun Lever  
 1Pc Carbon Fiber Storage Bag  
 1Pc 360° Universal Nozzle  
 1Pc Faucet Connection  
 1Pc Quick Connector

- Self-priming function
- 45-bar working pressure
- Ergonomic trigger design

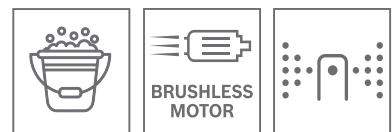



[www.voglertools.de](http://www.voglertools.de)

**6-In-1**  
Multifunctional Sprinkler

**1.5m**  
Water-Sucking Height

**20 v**

**4000 mAh**

**4 Liter/Minute**

**2.12 Kg**  
with 1Pc Battery Pack







[www.voglertools.de](http://www.voglertools.de)

**120** Nb of Shots/min

**18** Gauge

**20** v

**2000** mAh

**Lithium-ion**

**2.5** Kg  
with 1Pc Battery

# V10492

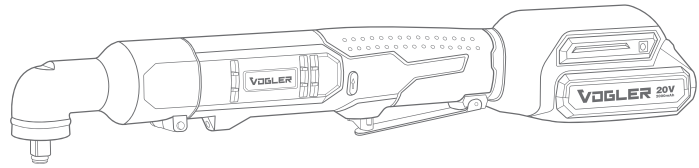

## Cordless Ratchet Wrench 20V

### TECHNICAL SPECIFICATION

Model	V10492
Head Style	Square
Material	Aluminum & Plastic
Dimension	(3/8") 9.5mm
Battery Type	Lithium-ion
Voltage	20V
Battery Capacity	2000mAh
No-Load Speed	0-2000RPM
Max Torque	80N.m
Total Weight	2.22Kg
Net Weight	1.58Kg
Accessories	2Pcs Battery Packs 1Pc Charger



- Powerful motor delivers 80 N.m of Max Torque
- Both forward and reverse rotation





[www.voglertools.de](http://www.voglertools.de)

<b>80</b> N.m	<b>20</b> v
<b>Square</b> Head Style	<b>2000</b> mAh
<b>Lithium-ion</b>	<b>1.58</b> Kg

# V18300

## Battery 20V 2.0Ah Li-ion Battery

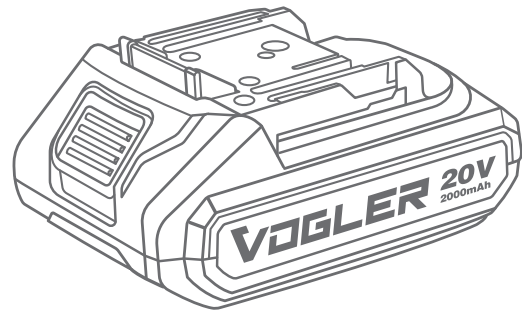

### TECHNICAL SPECIFICATION

Model	V18300
Battery Type	Lithium-ion
Battery Capacity	20V/2000mAh
Cell Capacity	3.7V/2000mAh
Number of Cells in the Battery Pack	5
Body Material	Nylon
Working Temperature Range	-3~70 °C
Weight	0.4Kg



# V18305

## Battery 20V 2.0Ah Li-ion Battery

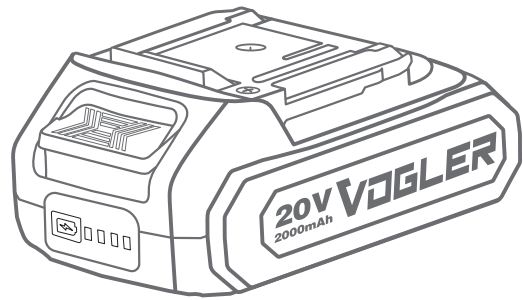

### TECHNICAL SPECIFICATION

Model	V18305
Battery Type	Lithium-ion
Battery Capacity	20V/2000mAh
Cell Capacity	3.7V/2000mAh
Number of Cells in the Battery Pack	5
Body Material	PA6+GF30
Working Temperature Range	0~45 °C
Weight	0.41Kg



[www.voglertools.de](http://www.voglertools.de)





# V18301

## Battery 20V 4.0Ah Li-ion Battery

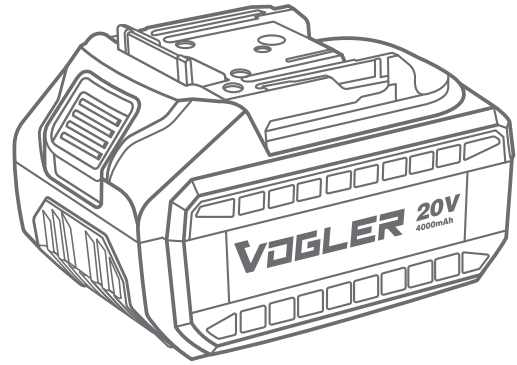

### TECHNICAL SPECIFICATION

Model	V18301
Battery Type	Lithium-ion
Battery Capacity	20V/4000mAh
Cell Capacity	3.7V/2000mAh
Number of Cells in the Battery Pack	10
Body Material	Nylon
Working Temperature Range	-3~70 °C
Weight	0.67Kg



[www.voglertools.de](http://www.voglertools.de)



# V18306

## Battery 20V 4.0Ah Li-ion Battery

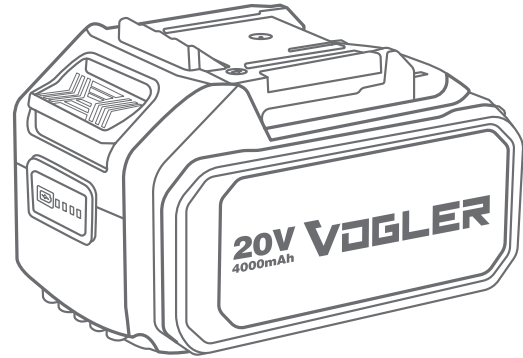

### TECHNICAL SPECIFICATION

Model	V18306
Battery Type	Lithium-ion
Battery Capacity	20V/4000mAh
Cell Capacity	3.7V/2000mAh
Number of Cells in the Battery Pack	10
Body Material	PA6+GF30
Working Temperature Range	0~45 °C
Weight	0.66Kg



[www.voglertools.de](http://www.voglertools.de)



# V19300

## Fast Charger

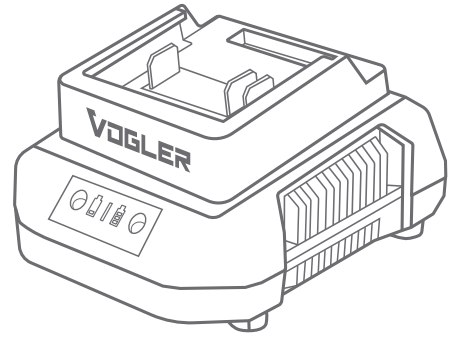

### TECHNICAL SPECIFICATION

Model	V19300
Input Voltage / Frequency	200-240V/50-60Hz
Output Voltage	22V
Max Output Current	2000mA
Body Material	Pc+ABS
Dimension	126×98×69mm
Plug Length	1.8m
Weight	0.26Kg

- Output: 22V/2000mA
- Input: 200-240V/50-60Hz



# V19305

## Charger

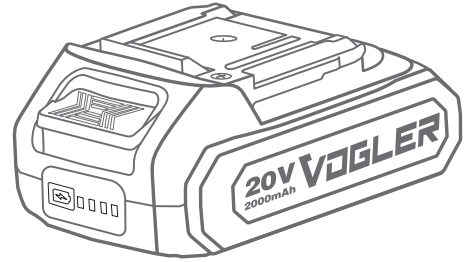

### TECHNICAL SPECIFICATION

Model	V19305
Input Voltage / Frequency	110-240V/50-60Hz
Output Voltage	20V
Max Output Current	2000mA
Body Material	PA6+GF30
Dimension	13x8.9x7.1mm
Plug Cable Length	1.8m
Weight	0.33Kg

- Output: 20V-2000mA
- Input: 110-240V/50-60Hz



[www.voglertools.de](http://www.voglertools.de)



# V19302

## Fast Charger

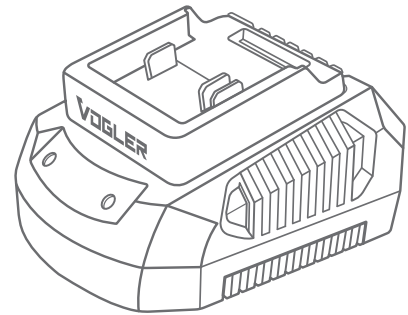

### TECHNICAL SPECIFICATION

Model	V19302
Input Voltage / Frequency	200-240V/50-60Hz
Output Voltage	22V
Max Output Current	4000mA
Body Material	Pc+ABS
Dimension	138×108×73mm
Plug Cable Length	1.8m
Weight	0.39Kg

- Output: 22V/4000mA
- Input: 200-240V/50-60Hz



# V18205

## Battery 2.0Ah Li-ion Battery

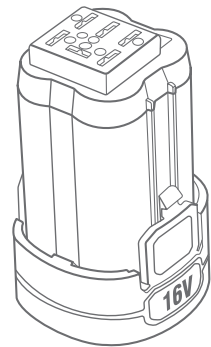

### TECHNICAL SPECIFICATION

Model	V18205
Battery Type	Lithium-ion
Battery Capacity	16V/2000mAh
Cell Capacity	3.7V/2000mAh
Number of Cells in the Battery Pack	4
Body Material	PA6+GF30
Working Temperature Range	0~45 °C
Weight	0.24Kg



[www.voglertools.de](http://www.voglertools.de)



# V19205

## Charger

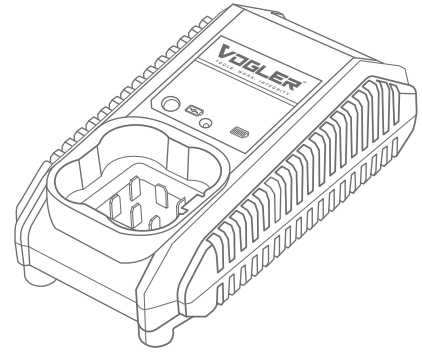

### TECHNICAL SPECIFICATION

Model	V19205
Input Voltage / Frequency	220-240V/50-60Hz
Output Voltage	16.8V
Max Output Current	1300mA
Body Material	PA6+GF30
Dimension	12.8x6.6x4.5mm
Plug Cable Length	1.8m
Weight	0.21Kg

- Output: 16.8V/1300mA
- Input: 220-240V/50-60Hz



# V19301

## Fast Charger

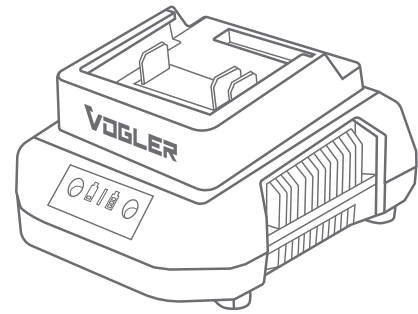

### TECHNICAL SPECIFICATION

Model	V19301
Input Voltage / Frequency	110V/60Hz
Output Voltage	22V
Max Output Current	2000mA
Body Material	Pc+ABS
Dimension	126×98×69mm
Weight	0.27Kg

- Output: 22V/2000mA
- Input: 110V/60Hz





# V19303

## Fast Charger

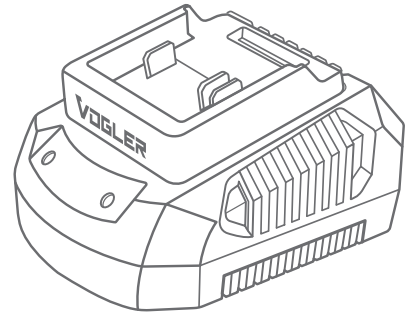

### TECHNICAL SPECIFICATION

Model	V19303
Input Voltage / Frequency	110V/60Hz
Output Voltage	22V
Max Output Current	4000mA
Body Material	ABS+Pc
Dimension	138×108×73mm
Weight	0.4Kg

- Output: 22V-4000mA
- Input: 110V/60Hz



Vogler's mission doesn't stop with cordless tools. By incorporating the latest technologies and maintaining the highest standards in Germany's tool industry, Vogler aims to expand its collection with a wide range of products, including electric tools, hand tools, tool accessories, measuring tools, and more.

**Other Products Coming Soon...**

**Other Products**

**COMING**

**Soon**

**Until 2025**

# POWER TOOLS

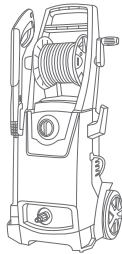

**Pressure Washer**

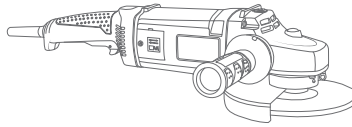

**Grinder**

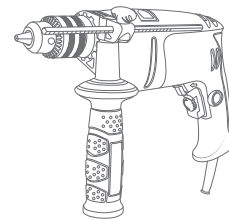

**Electric Drill**

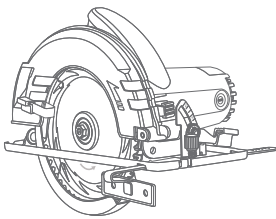

**Electric Circular Saw**

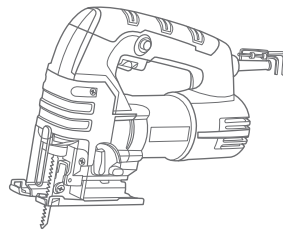

**Electric Jigsaw**

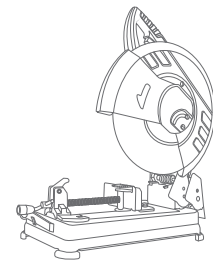

**Cut-Off Saw**

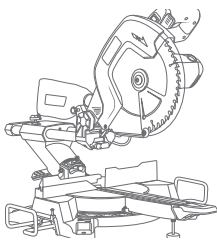

**Sliding Miter Saw**

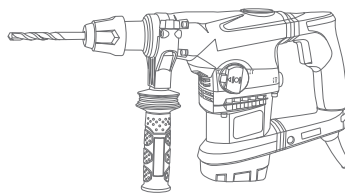

**Rotary Hammer**

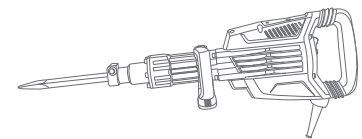

**Demolition Hammer**

# ACCESSORIES

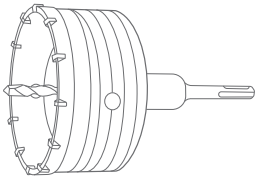

**Hollow Hammer**

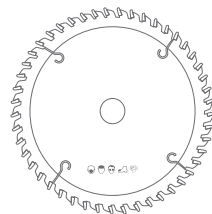

**Circular Saw Blade**

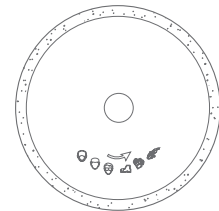

**Ceramic Cutting Disc**

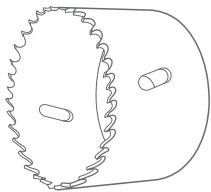

**Bimetal Hole Saw**

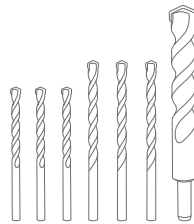

**Masonry Drill Bit**

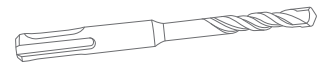

**SDS Plus Drill Bit**



**SDS Plus Chisel Bit**



**Hex Flat Chisel**



**Hex-Pointed Chisel Bit**



# AIR TOOLS

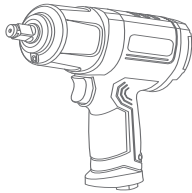

**Air Impact Wrench**

---

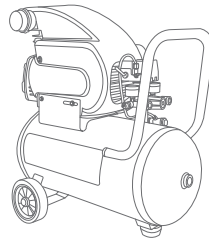

**Air Compressor**

---

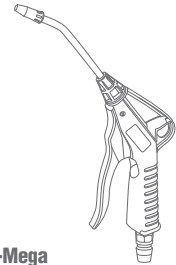

**Air Blow Gun-Mega**

---

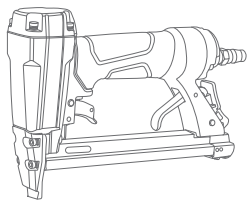

**Crown Stapler 21-Gauge**

---

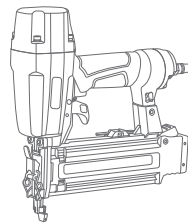

**Brad Nailer**

---

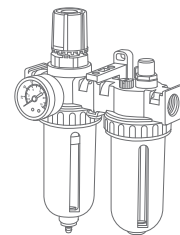

**Double Air Filter Regulator**

---

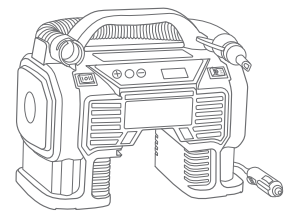

**Mini Digital Air Compressor**

---

# HAND TOOLS

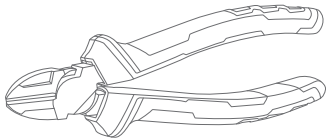

**Diagonal Cutting Plier**

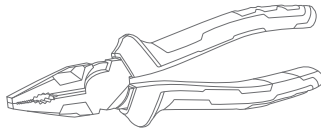

**Combination Plier**



**Adjustable Wrench 10 Inch-Libra**

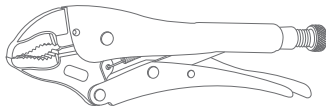

**Locking Pliers**

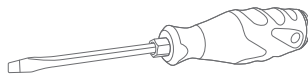

**TPR Hammering Screwdriver**

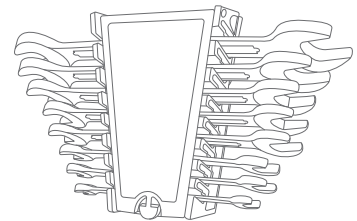

**Double Open-End Spanner Set**

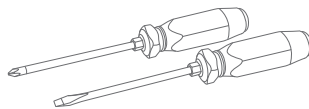

**Slotted & Phillips Hammering  
Screwdriver**

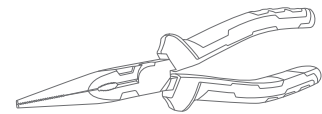

**Long Nose Plier**



# GARDENING TOOLS

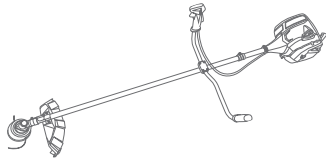

**Gasoline Brush Cutter**



**Gasoline Hedge Trimmer**

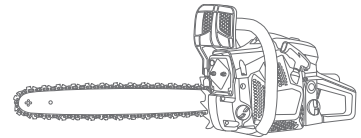

**Gasoline Chainsaw**

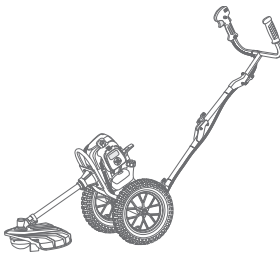

**Wheeled Brush Cutter**

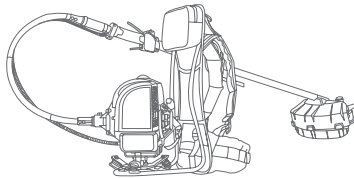

**Gasoline Backpack Brush Cutter**

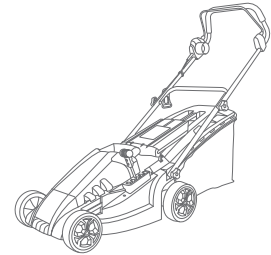

**Electric Lawn Mower**





# VOGLER<sup>®</sup>

TOOLS, WORK, INTEGRITY



Blindeisenweg 37, 41468 Neuss, Germany  
Tel: +49 2131 2048971 [www.voglertools.de](http://www.voglertools.de)